

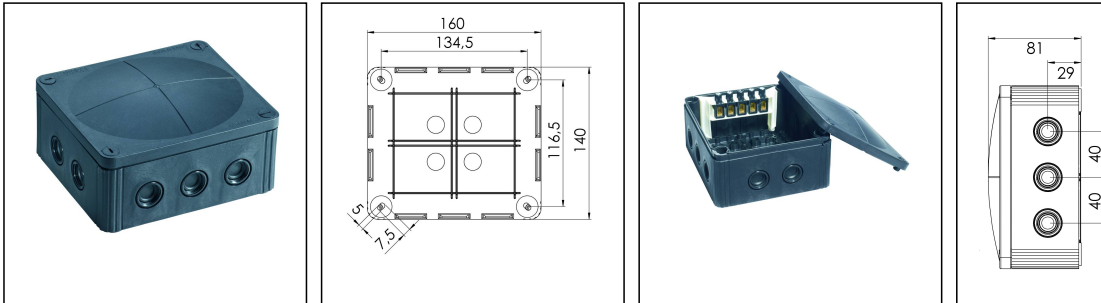

COMBI 1210/5/S

Junction box, polypropylene



Product illustrations are exemplary and may differ from the chosen product. Further variants and individual customization, we will gladly provide you on request.



Material	Polypropylene
Material sealing gasket	TPE
Temp. range min	-30 °C
Temp. range max	100 °C
Temperatures during install.	-5 °C - 60 °C
Protection class	IP66/67
Glow wire test	750 °C
Voltage	690 V
Terminals/poles	10 mm ²
Terminals/poles	5 x 10mm ²
Fixing	4 internal openings
Ø cable diameter min	3 mm
Ø cable diameter max	12 mm
External dimensions LxWxH	160 x 140 x 81mm
Using for cable gland	
Product Color	RAL 9005
WISKA-Order no.	10101463
Type	COMBI 1210/5/S
Packing unit	2
ETIM-Classification	EC002600

Remarks:

IP66: using the membrane entry

IP67: using the threaded entry together with

ESKV cable gland

Mounting: 4 internal openings outside of the sealing area

WISKA Hoppmann & Mulsow GmbH
 Kisdorfer Weg 28 · 24568 Kaltenkirchen · Germany
 ☎ +49-4191-508-0 · 📠 +49-4191-508-209
 contact@wiska.com · www.wiska.com

Equipment: 10 entries M20 with elastic soft membrane and thread and M25 knockout
4 entries with self-sealing membrane at the bottom (M20)
4 captive cover screws
inclusive 5-pole terminal 10mm²

06.09.2016

