

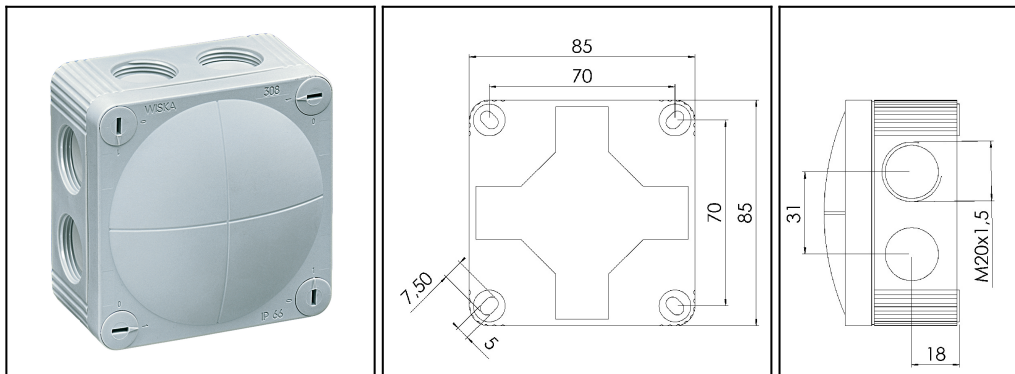













## WISKA COMBI 308



<b>Protection class to EN 60 529:</b>	IP 66
<b>Flame protection:</b>	Glow wire test 750 C acc. to EN 60695-2-11
<b>Temperatures during installation:</b>	-5°C to 60°C
<b>Temperature range of material:</b>	-30°C to 100°C, intermittent up to approx. 120°C
<b>Voltage:</b>	400 V
<b>Material:</b>	Polypropylene, reinforced glass fibre; Sealing: thermoplastic elastomere
<b>Terminals/poles:</b>	4 mm <sup>2</sup>
<b>Fixing:</b>	With mounting clip or 4 internal openings outside of the sealing area
<b>Equipment:</b>	8 elastic self-sealing membranes for cable entry without mechanical devices
	- 8 integrated M 20 threads, no locknuts necessary
	- 4 captive quick-release lid screws
	- Incl. mounting clip for snap-on fixing
	- Colour RAL 7035 light grey
	- .../S = black
	- .../W = white
	- .../DR = grey box with red cover
	- .../ESKV = incl. 3 pcs. ESKV M 20 (*Sealing range 6 - 13 mm)
<b>Accessories:</b>	- DN 48: screwing sleeves for fixing profile rails, WISKA-No. 10060372
	- DIN RAIL KIT 108, 308: Rail TS 15 + Fixing material, WISKA-No. 10060362
	- EC 308 Earthing plate: WISKA No. 10101473
	- Adapter 308/1210: WISKA No. 10101477

Type	WISKA-No.		 mm		L x B x H external / außen mm
COMBI 308/leer	10060400	5/100	3 - 12		85 x 85 x 51
COMBI 308/leer/S	10060581	5/100	3 - 12		85 x 85 x 51
COMBI 308/leer/W	10060610	5/100	3 - 12		85 x 85 x 51
COMBI 308/leer/DR	10060480	5/100	3 - 12		85 x 85 x 51
COMBI 308/ESKV	10060403	5/100	3 - 12*		85 x 85 x 51
COMBI 308/5	10060401	5/100	3 - 12		85 x 85 x 51
COMBI 308/5/S	10060580	5/100	3 - 12		85 x 85 x 51
COMBI 308/5/W	10060611	5/100	3 - 12		85 x 85 x 51
COMBI 308/FK 150	10060530	5/100	3 - 12		85 x 85 x 51
COMBI 308/FK 230	10060520	5/100	3 - 12		85 x 85 x 51
COMBI 308/FK 250	10060521	5/100	3 - 12		85 x 85 x 51
DIN RAIL KIT 308	10060362	1	—	—	--

© 2014 WISKA Hoppmann & Mulsow GmbH

Kisdorfer Weg 28

D-24568 Kaltenkirchen

Phone: +49 (0)4191 / 508-100

Fax: +49 (0)4191 / 508-209